

PANIC EXIT DEVICES GIESSE

Safety and security from innovation

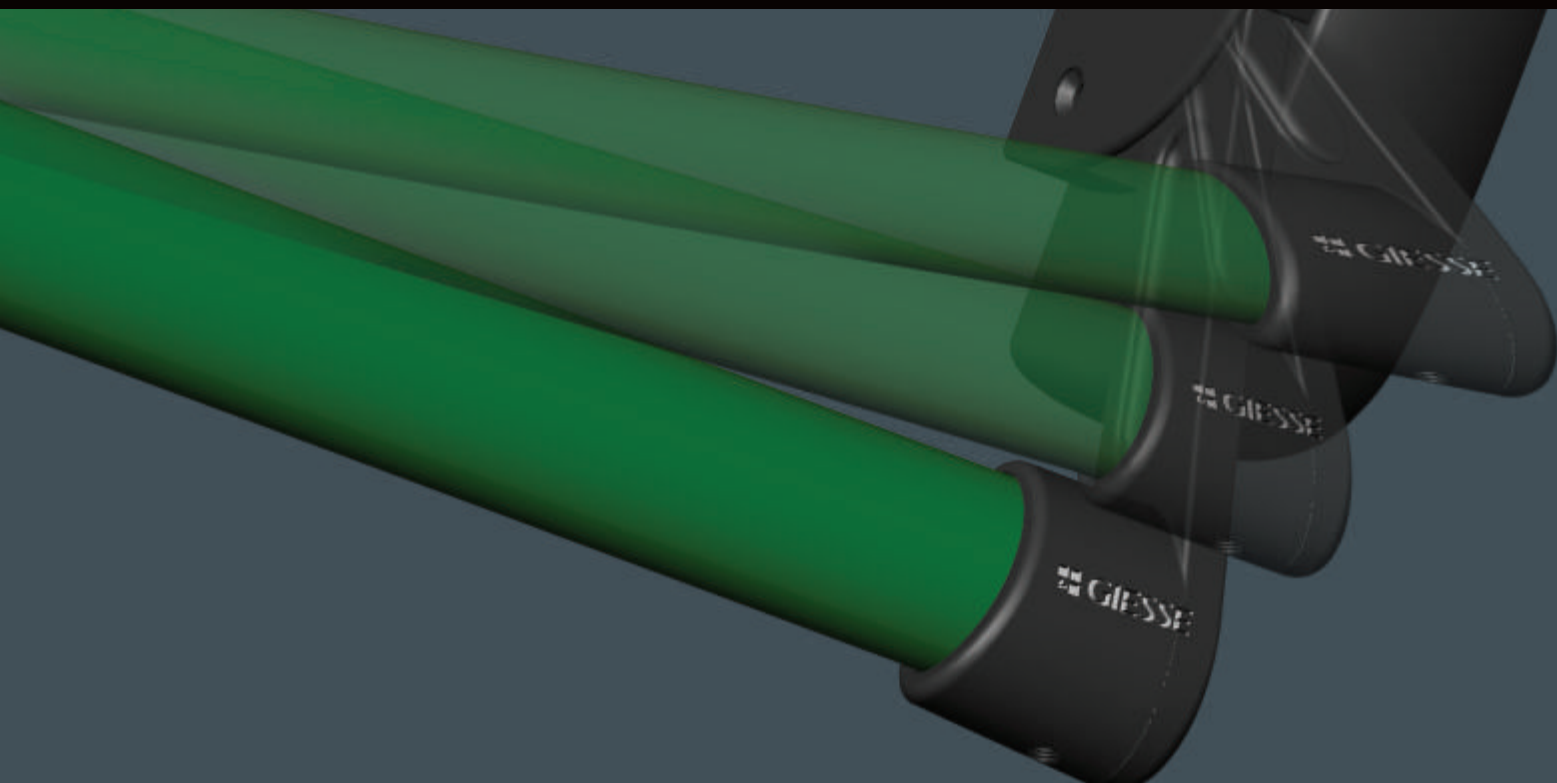

GS AP PROGRAMME GIESSE

Panic devices for Giesse door manufacturer



The project

A complete and innovative range

Innovative technological solutions and certified performance

GIESSE presents a complete range of panic exit devices for emergency exits, featuring high reliability, and an ergonomic and innovative design, which combines perfectly the requirements of safety and facility of use with good looks.

In all public and most industrial places, the management of panic exits has grown in importance over the last few years, with the aim of increasing the safety of environments attended by people unprepared to deal with emergency situations. Giesse, which for more than 40 years has been in the aluminium door and window business accumulating a wealth of experience, has developed a new generation of panic exit devices which combine innovative technological solutions with an attractive design. The performance is certified according to the highest legal standards.



Advantages

1

A wide range

Giesse has a wide range of panic bars available in the PUSH BAR and TOUCH BAR application versions, and in the GS AP100 security insert version.

2

CE certified panic exits

The components in the range were designed so as to guarantee easy and safe action of the device in emergency situations. The oval shape of the extruded aluminium bar, was developed to make it easy to grip and operate. The Giesse bars have been certified according to the UNI EN 1125:2008 standard and authorized for use of the CE mark with the highest performance levels.

3

Fire doors

The application models (PUSH BAR AP001 and TOUCH BAR AP002) also come in versions suitable for application on fire doors.

4

Security

The insert version, GS AP100, is fitted with a lock with one or three locking points (multipoint) to ensure greater security against intruders.

5

Reliable

The careful design, the adoption of highly resistant materials, the efficiency of the mechanisms and the perfect assembly of the components all guarantee that the bars will have a long operational life.

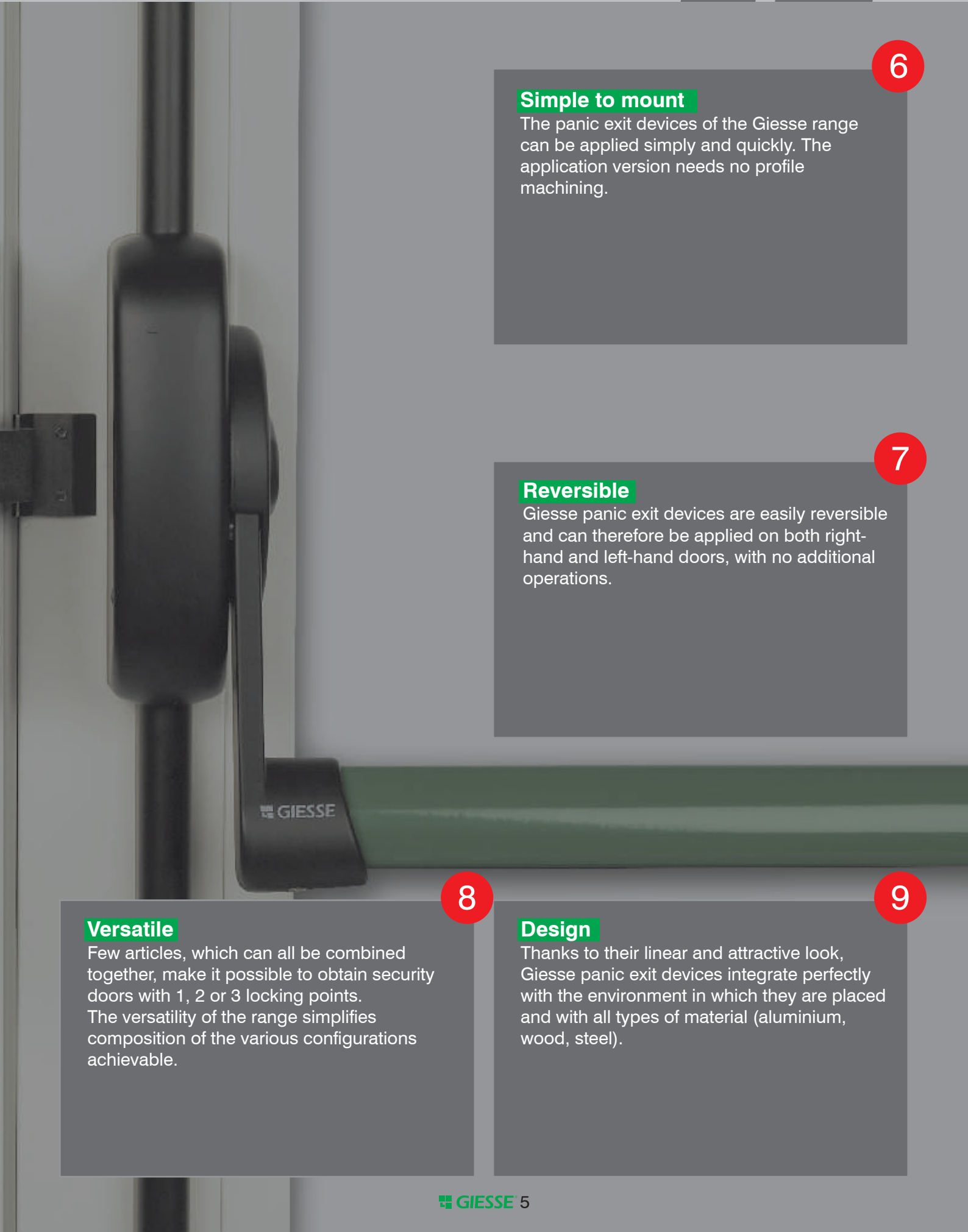

6

Simple to mount

The panic exit devices of the Giesse range can be applied simply and quickly. The application version needs no profile machining.

7

Reversible

Giesse panic exit devices are easily reversible and can therefore be applied on both right-hand and left-hand doors, with no additional operations.

8

Versatile

Few articles, which can all be combined together, make it possible to obtain security doors with 1, 2 or 3 locking points. The versatility of the range simplifies composition of the various configurations achievable.

9

Design

Thanks to their linear and attractive look, Giesse panic exit devices integrate perfectly with the environment in which they are placed and with all types of material (aluminium, wood, steel).

GS AP001

*GS AP001 the
PUSH BAR
version panic exit
device*

GS AP001 is the panic device for PUSH BAR applications which combines easy assembly, a long working lifetime, compatibility with most profiles, attention to design and highly certified performance, all in one.

The vast range enables panic exits to be created for every situation.

The GS AP001 application panic device is made using three fundamental elements:

- **mechanisms** (available in lateral, top/bottom and modular versions)
- **operation bars** (available in three different widths)
- **supplementary latches** (available in top/bottom and lateral versions).

Reliability of the devices is guaranteed by the **high quality and resistance of the materials** selected. The mechanism is made of galvanised steel, the bar of extruded aluminium and the supplementary locking points (latches) of stainless steel. Bolt guards are made of galvanised steel.

The GS AP001 devices are available in the following **versions**:

- with one locking point and lateral bolt
- with two locking points and no lateral bolt but with supplementary vertical and lateral top/bottom latches
- with three locking points (modular version) with lateral bolt plus

supplementary top/bottom vertical and lateral latches

All latches (on bars and supplementary) come with strikers. The GS AP001 bars are supplied pre-mounted for right-hand application. Simply by rotating the clamp from its position in the packaging, left-hand application becomes possible.

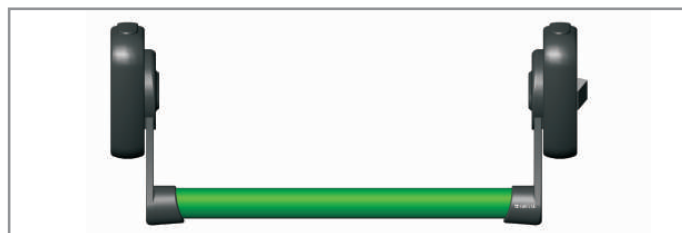

The GS AP001 panic device is also available (with different codes) in a **fire door version** (GS AP001 F). The difference consists of the use of **specific stainless steel strikers**, which ensure that the

safety device works, and thus the door opens, also in the event of a fire.

GS AP001 is applied to panic doors with one or two wings.

GS AP002 the TOUCH BAR version panic exit device

GS AP002 is the panic device for TOUCH BAR applications which combines easy assembly, a long working lifetime, compatibility with most profiles, attention to design and highly certified performance, all in one.

The vast range enables panic exits to be created for every situation.

The fundamental feature of the GS AP002 application bar is that it is supplied **pre-assembled with the operation bar**.

Mounting the panic exit device is particularly easy and quick: it only has to be placed against the door and fixed using the supplied screws.

Reliability of the devices is guaranteed by the **high quality and resistance of the selected materials**. The mechanism is made of galvanised steel, the bar of extruded aluminium and the supplementary locking points (latches) of stainless steel. Bar cover guards and bolt guards are made of galvanised steel.

GS AP002 is available in three different lengths, in the following **versions**:

- with one locking point and lateral bolt



- with two locking points and no lateral bolt but with supplementary vertical and lateral top/bottom latches
- with three locking points (modular version) with lateral bolt plus supplementary top/bottom vertical and lateral latches

All latches (both on mechanisms and supplementary) come with strikers.

The GS AP002 is both right-hand and left-hand, so mounting on doors opening to the right or the left involves no operations on the device.

The GS AP002 panic device is also available (with different codes) in a **fire door version** (GS AP002 F). The difference consists of the use of **specific stainless steel strikers**, which ensure that the safety device works, and thus the door opens, also in the event of a fire.

GS AP002 is applied to panic doors with one or two wings.

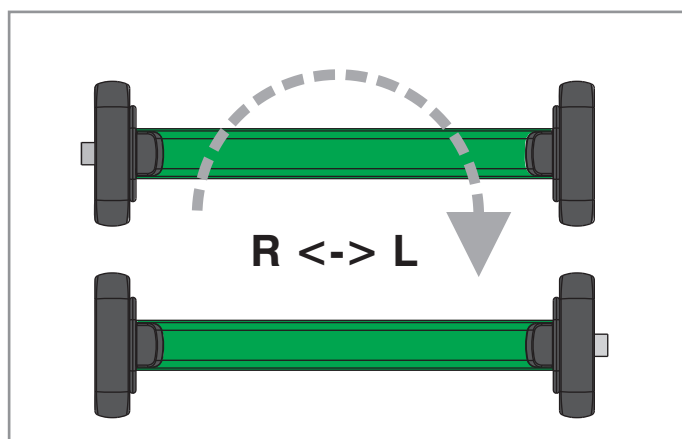

PANIC EXIT DEVICES GIESSE

Components for GS AP001 and GS AP002

SUPPLEMENTARY LATCHES

The GS AP001 and GS AP002 panic exit device application models are available with **supplementary locking points** (latches) which make the door more secure.

The supplementary latches are available in the following **versions**:

- with vertical top/bottom locking (available in two different heights)
- with lateral top/bottom locking (available in two different heights.)

All supplementary latches are supplied with the relevant strikers.

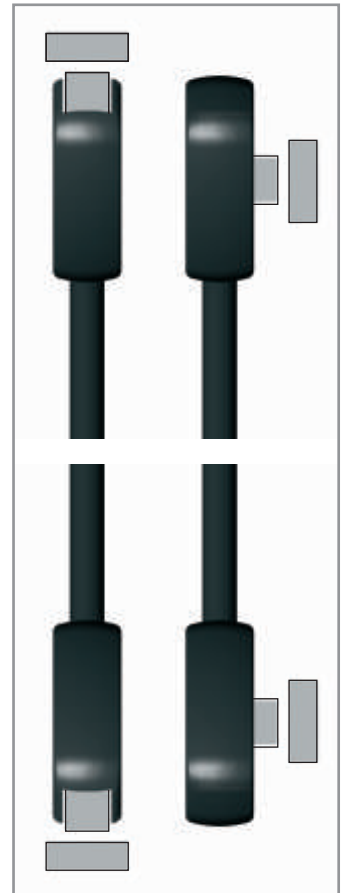

STRIKERS FOR LATCHES

The strikers of the GS AP001 and GS AP002 application panic exit devices are available in the following **versions**:

- bolt strikers (standard and fire door version) adjustable to be placed in a position corresponding to the lateral or vertical

latches

- floor striker to be placed in a position corresponding to the bottom vertical bolt.

The strikers exist individually as accessories but are already supplied with the panic exit devices and supplementary latches.



Standard version



Fire door version

EXTERNAL CONTROL

The external control common to all GS AP001 and GS AP002 panic exit devices is a device to be applied on the outside of the door, enabling it to be opened from the outside.

Available in **versions with handle and knob**, the external control can also be fitted with a Europrofile cylinder (DIN cam) of various sizes, and with a master-key system.



GS AP100

GS AP100 the security panic exit device

The AP100 security insertion panic exit device fitted with a **single or multipoint lock**, provides extra security against intrusion.

GS AP100 is compatible with most of the commercial profiles available on the market, guaranteeing high reliability and certified performance, and has a linear and attractive design that integrates perfectly with the environment in which it is placed.

The insertion device is made using the following elements:

- **the mechanism**
- **the operation bar** (available in three different widths)
- **the lock** (available in single or multipoint version)
- **the single striker for the central lock** (with one locking point) **or the striker kit for multipoint locks** (with 3 locking points)
- **the cylinder** (available in various widths and types).

The GS AP100 locks are available with three different backsets and different face plates according to the type of profile:

- “U”-shaped for door-type profiles (with no groove)
- flat for grooved profiles.



The entire range of locks is reversible and compatible with European profile cylinders .

The face plate is in stainless steel and the components of the lock in galvanized steel.

The special feature of these locks, compared with traditional door locks, is that pressing on the operation bar, if inserted, deactivates the locking device (bolt and latches).

PANIC EXIT DEVICES GIESSE

GS AP100

GS AP100 the security panic exit device

GS AP100 comes with two series of strikers, in stainless steel and zamak, adjustable in the three directions (height – width - depth): one for the central lock, and a locking kit for the multipoint lock for **application on the most common profiles on the market:**

- Euro groove
- door type
- R40-R50
- new Nc40
- flush profiles
- iron.

GS AP100 can be applied to all profiles with a thickness equal to or more than 32.5 mm.

The use of Giesse strikers is compulsory in order to retain CE certification.

GS AP100 is either left- or right-handed and requires no further adaptations.

GS AP100 is applied to doors with one wing.

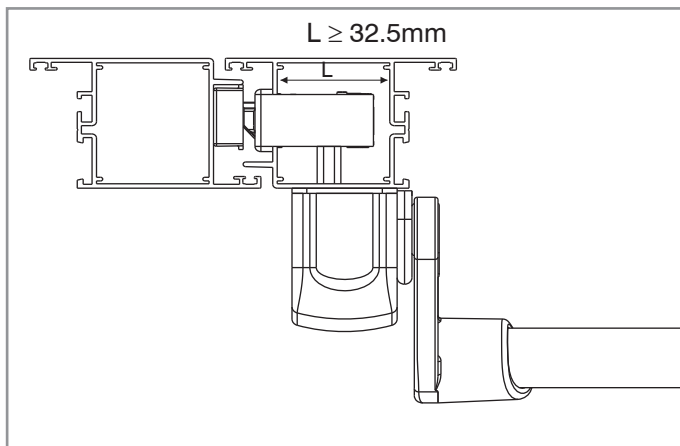
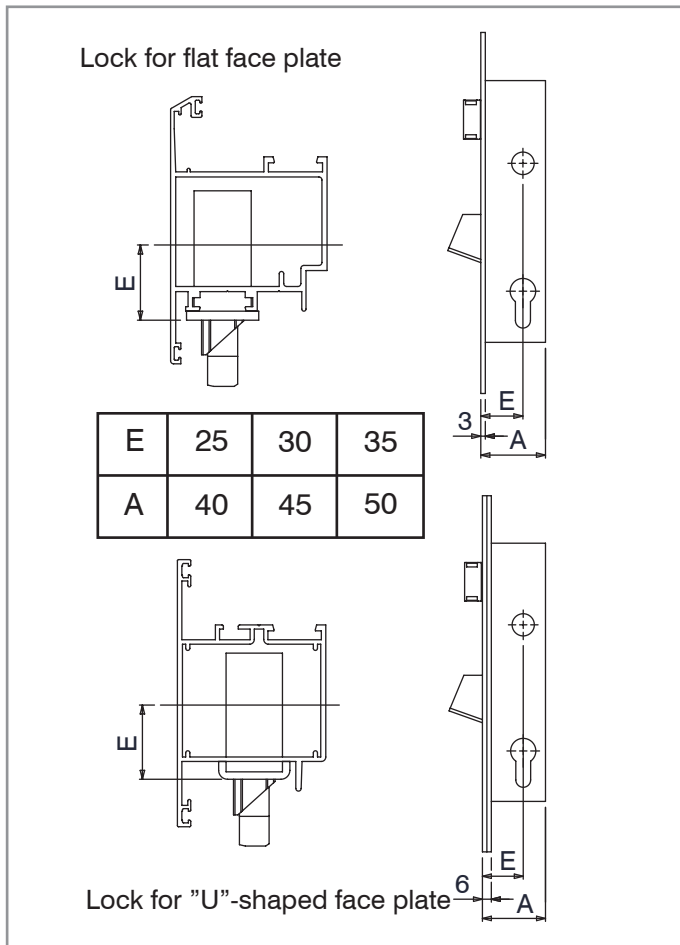

PANIC EXIT DEVICES GIESSE

CE certified panic exits

CE certification
at the highest
performance
levels

Giesse panic exit devices are made so as to guarantee easy and safe operation of the device in emergency

situations and are certified in conformity with the **European EN 1125:2008 standard** and authorized for use

of the **CE Mark** exhibiting the following high performance levels.

GS AP001



UNI EN 1125:2008, description of performance levels:

1st character - **CATEGORY OF USE**
Grade 3 = high frequency of use, suitable for use in public buildings

2nd character - **DURABILITY/NUMBER OF CYCLES**
Grade 7 = 200,000 cycles

3rd character - **DOOR MASS**
Grade 6 = up to 200 kg
Grade 7 = over 200 kg

4th character - **SUITABILITY FOR USE ON FIRE/SMOKE DOORS (*)**
Grade 0 = not approved
Grade B = suitable

5th character - **SAFETY IN USE**
Grade 1 = maximum level of safety

6th character - **CORROSION RESISTANCE**
Grade 4 = very high resistance (240 hours in conformity with EN1670:2007)

7th character - **SECURITY**
Grade 2 = maximum level of security

8th character - **PROJECTION OF HORIZONTAL BAR**
Grade 1 = up to 150 mm
Grade 2 = up to 100 mm

9th character - **TYPE OF DEVICE**
Type A = panic exit device with "push-bar" operation
Type B = panic exit device with "touch-bar" operation

10th character - **FIELD OF DOOR APPLICATION**
Type A = single door or double door
Type B = single door only

GS AP001 F

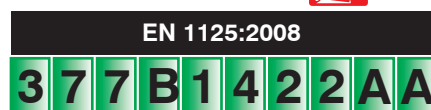

GS AP002

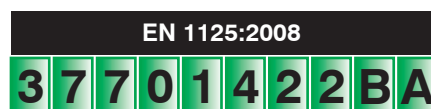

GS AP002 F

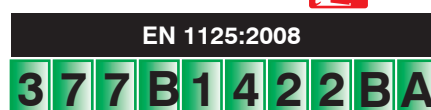

GS AP100



(*) Suitability for use on fire doors which does not replace the obligation to homologate the door in conformity with EN 1634-01/02/03.

LIMITS FOR RETENTION OF CE CERTIFICATION

MAXIMUM WEIGHT OF THE DOOR	no limits for sash weight
MAXIMUM HEIGHT OF THE DOOR	2500 mm
MAXIMUM WIDTH OF THE DOOR	1300 mm
NORMAL OPERATING TEMPERATURE RANGE	-20°C/+100°C

Fire doors

Safety and functionality also in the event of fire

The Giesse range of application panic exit devices includes two versions, GS AP001 F and GS AP002 F, which are suitable for application on fire doors.

These versions are different from the standard ones in their use of **specific strikers, in stainless steel**, which ensure that the safety device works, and thus the door opens, also in the event of a fire.



Simple to mount

Few, simple and intuitive operations

Installation of the Giesse panic exit devices is simple and quick. With the help of the templates provided in the assembly instructions (fig. 1) supplied with the product, work is done on the profiles (holes drilled). Installation of the strikers requires a number of holes to be drilled using the strikers themselves as templates.

More work is needed on the profile in the case of mounting the GS AP100 security insertion model (fig. 2).

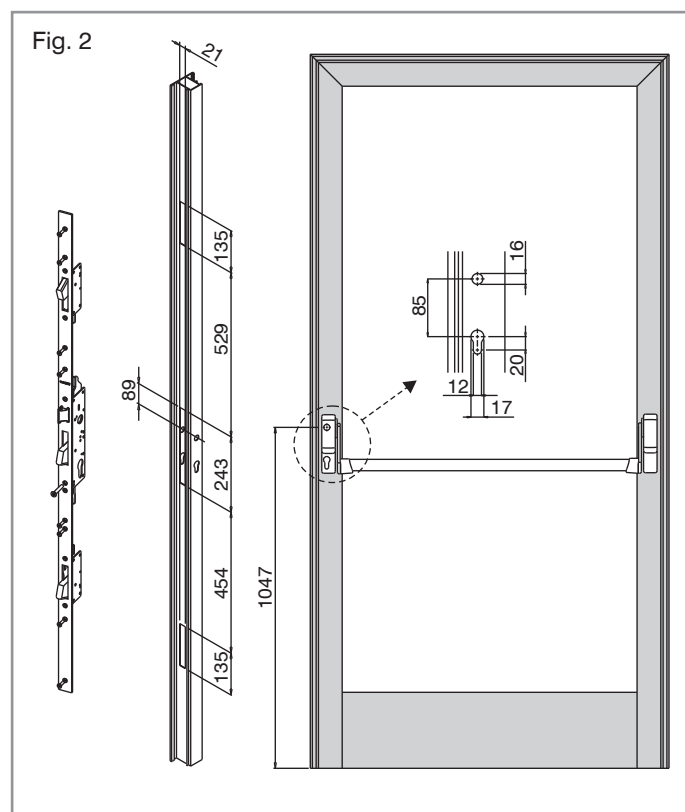
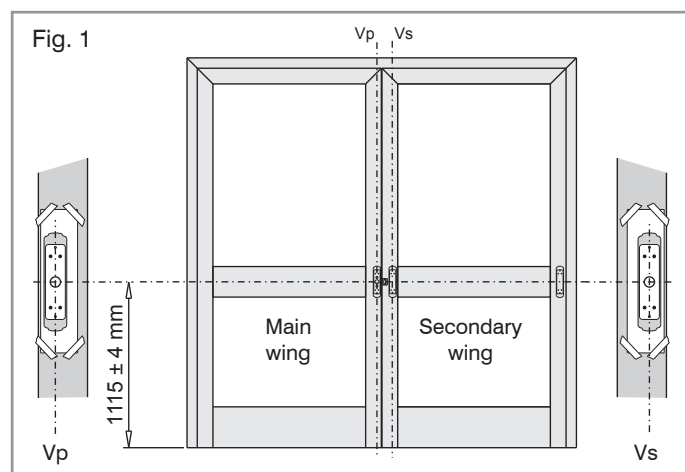

Versatile

GS AP001 and GS AP002: any type of lock with only a few items

Using a limited number of items, the Giesse bars of the GS AP001 and GS AP002 **application range** enable various types of configurations for doors with one and two wings.

The **lateral version bar** enables the creation of a panic door with **a lateral locking point**. The **top/bottom version bar** combined with the supplementary latches enables the creation of a panic door with **two lateral or vertical locking points**.

The **modular version bar**, which can be combined with supplementary latches, enables the creation of a panic door with **one lateral locking point, two lateral or vertical locking points, or three lateral** (or two vertical and one lateral) **locking points**.

Finally two winged security doors can be made, again with lateral points (one, two or three points) locking the main wing into the secondary wing.

The modularity of the product, together with the individual packaging of each item, brings the advantage of working with a limited number of articles in stock.

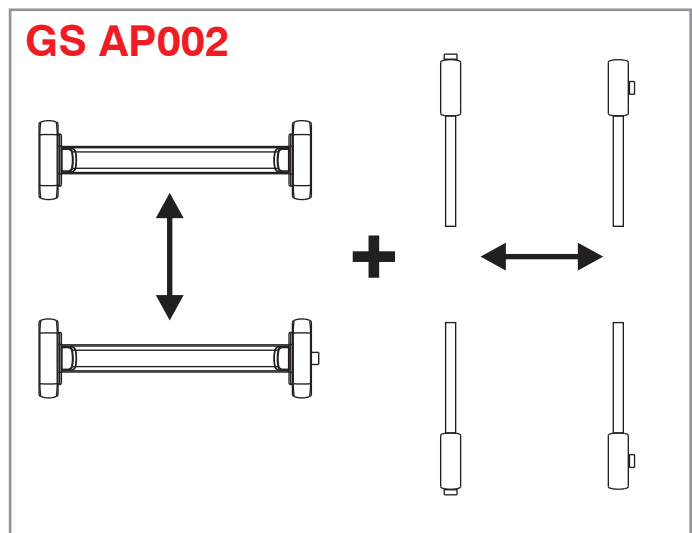
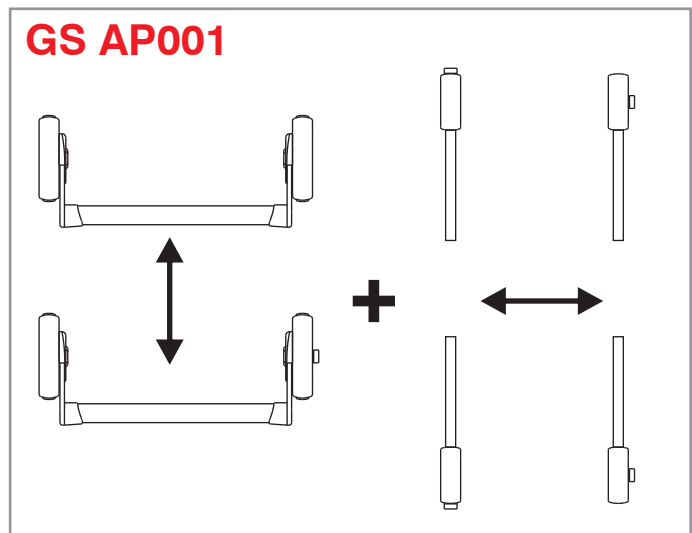

PANIC EXIT DEVICES GIESSE

Versatile

GS AP100: locks with single or triple locking points and external controls with keys to protect buildings from attempted intrusion

The Giesse AP100 **insert version device bar** with lock, enables the creation of various types of configurations **for doors with one wing**, ensuring high performance in terms of security and resistance.

The GS AP100 security bar enables the production of a panic door with **a lateral locking point** if combined with a central lock and **three lateral locking points** if combined with a

multipoint lock.

GS AP100 is applied to doors with one wing.

GS AP100

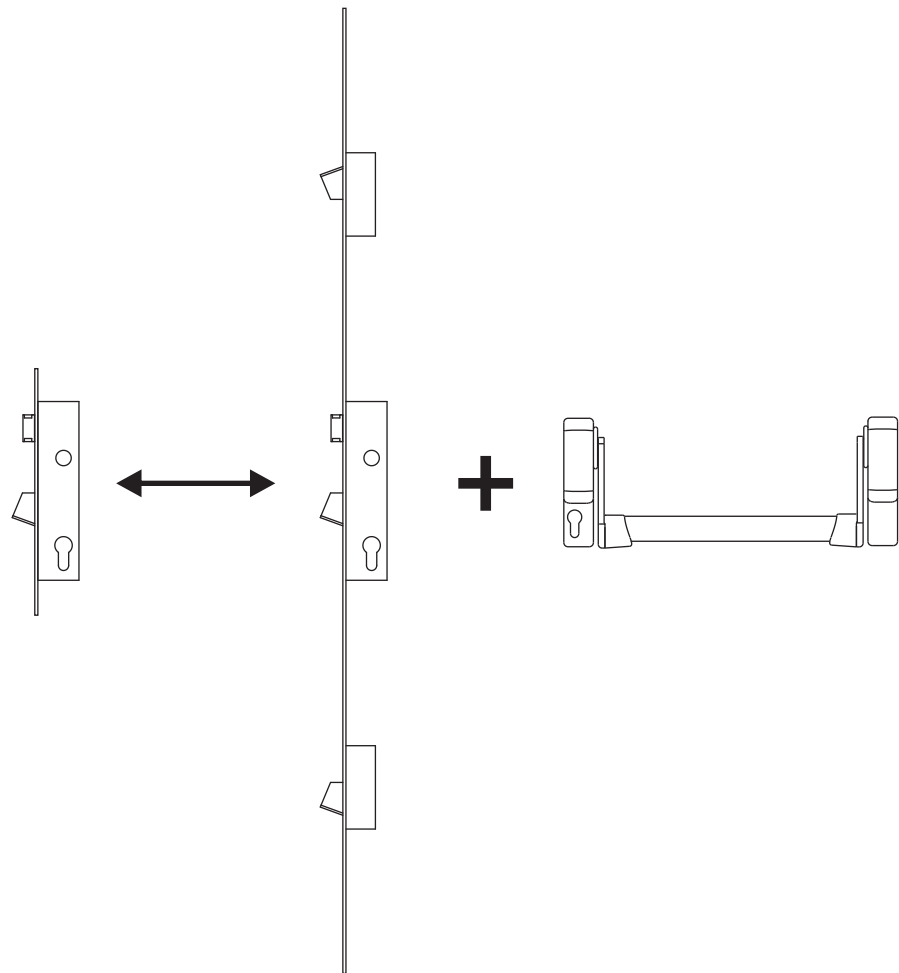

CONFIGURATIONS



PANIC EXIT DEVICES GIESSE

Configurations GS AP001

Type	Pcs.	Description	Codice	Notes
	1	GS AP001 lateral mechanism	07830...N	
	1	950 mm bar	07843...	For door widths up to 1000mm
	1	1150mm bar	07844...	For door widths from 1001 to 1200 mm
	1	1450mm bar	07845...	For door widths from 1201 to 1500mm
	1	GS AP001 top/bottom mechanism	07831...N	
	1	Short vertical suppl. latches	07835...N	For door heights up to 2640mm
	1	Long vertical suppl. latches	07836...N	For door heights from 2641 to 3150mm
	1	950mm bar	07843...	For door widths up to 1000mm
1	1150mm bar	07844...	For door widths from 1001 to 1200mm	
1	1450mm bar	07845...	For door widths from 1201 to 1500mm	
	1	GS AP001 top/bottom mechanism	07831...N	
	1	Short lateral suppl. latches	07837...N	For door heights up to 2640mm
	1	Long lateral suppl. latches	07838...N	For door heights from 2641 to 3150mm
	1	950mm bar	07843...	For door widths up to 1000mm
1	1150mm bar	07844...	For door widths from 1001 to 1200mm	
1	1450mm bar	07845...	For door widths from 1201 to 1500mm	
	1	GS AP001 modular mechanism	07832...N	
	1	Short vertical suppl. latches	07835...N	For door heights up to 2640mm
	1	Long vertical suppl. latches	07836...N	For door heights from 2641 to 3150 mm
	1	950mm bar	07843...	For door widths up to 1000mm
1	1150mm bar	07844...	For door widths from 1001 to 1200mm	
1	1450mm bar	07845...	For door widths from 1201 to 1500mm	
	1	GS AP001 modular mechanism	07832...N	
	1	Short lateral suppl. latches	07837...N	For door heights up to 2640mm
	1	Long lateral suppl. latches	07838...N	For door widths from 2641 to 3150mm
	1	950mm bar	07843...	For door widths up to 1000mm
1	1150mm bar	07844...	For door widths from 1001 to 1200mm	
1	1450mm bar	07845...	For door widths from 1201 to 1500mm	

The three dots indicated in the codes of the products substitute, on this page, the three numbers of the finishing that may be ordered. For the Giesse finishing code, please refer to the "How to order" section on page 27

Type	Pcs.	Description	Code	Notes
	1	GS AP001 lateral mechanism	07830...N	
	1	GS AP001 top/bottom mechanism	07831...N	
	1	Short vertical suppl. latches Long vertical suppl. latches	07835...N 07836...N	For door heights up to 2640mm For door heights from 2641 to 3150mm
	2	950mm bar 1150mm bar 1450mm bar	07843... 07844... 07845...	For door widths up to 1000mm For door widths from 1001 to 1200mm For door widths from 1201 to 1500mm

	2	GS AP001 top/bottom mechanism	07831...N	
	1	Short vertical suppl. latches Long vertical suppl. latches	07835...N 07836...N	For door heights up to 2640mm For door heights from 2641 to 3150mm
	1	Short lateral suppl. latches Long lateral suppl. latches	07837...N 07838...N	For door heights up to 2640mm For door heights from 2641 to 3150mm
	2	Barra 950mm Barra 1150mm Barra 1450mm	07843... 07844... 07845...	For door widths up to 1000mm For door widths from 1001 to 1200mm For door widths from 1201 to 1500mm

	1	GS AP001 top/bottom mechanism	07831...N	
	1	GS AP001 modular mechanism	07832...N	
	1	Short vertical suppl. latches Long vertical suppl. latches	07835...N 07836...N	For door heights up to 2640mm For door heights from 2641 to 3150mm
	1	Short lateral suppl. latches Long lateral suppl. latches	07837...N 07838...N	For door heights up to 2640mm For door heights from 2641 to 3150mm
	2	950mm bar 1150mm bar 1450mm bar	07843... 07844... 07845...	For door widths up to 1000mm For door widths from 1001 to 1200mm For door widths from 1201 to 1500mm

1 = main wing
2 = secondary wing

The three dots indicated in the codes of the products substitute, on this page, the three numbers of the finishing that may be ordered. For the Giesse finishing code, please refer to the "How to order" section on page 27

PANIC EXIT DEVICES GIESSE

Configurations GS AP001 F

Type	Pcs.	Description	Code	Notes
	1	GS Ap001 F lateral mechanism	07310...	
	1	950mm bar	07843...	For door widths up to 1000mm
	1	1150mm bar	07844...	For door widths from 1001 to 1200mm
	1	1450mm bar	07845...	For door widths from 1201 to 1500mm
	1	GS AP001 top/bottom mechanism	07831...N	
	1	Short vertical suppl. latches	07315...	For door heights up to 2640mm
	1	Long vertical suppl. latches	07316...	For door heights from 2641 to 3150mm
	1	950mm bar	07843...	For door widths up to 1000mm
	1	1150mm bar	07844...	For door widths from 1001 to 1200mm
	1	1450mm bar	07845...	For door widths from 1201 to 1500mm
	1	GS AP001 top/bottom mechanism	07831...N	
	1	Short lateral suppl. latches	07317...	For door heights up to 2640mm
	1	Long lateral suppl. latches	07318...	For door heights from 2641 a 3150mm
	1	950mm bar	07843...	For door widths up to 1000mm
	1	1150mm bar	07844...	For door widths from 1001 to 1200mm
	1	1450mm bar	07845...	For door widths from 1201 to 1500mm
	1	GS AP001 F modular mechanism	07312...	
	1	Short vertical suppl. latches	07315...	For door heights up to 2640mm
	1	Long vertical suppl. latches	07316...	For door heights from 2641 a 3150mm
	1	950mm bar	07843...	For door widths up to 1000mm
	1	1150mm bar	07844...	For door widths from 1001 to 1200mm
	1	1450mm bar	07845...	For door widths from 1201 to 1500mm
	1	GS AP001 F modular mechanism	07312...	
	1	Short lateral suppl. latches	07317...	For door heights up to 2640mm
	1	Long lateral suppl. latches	07318...	For door heights from 2641 to 3150mm
	1	950mm bar	07843...	For door widths up to 1000mm
	1	1150mm bar	07844...	For door widths from 1001 to 1200mm
	1	1450mm bar	07845...	For door widths from 1201 to 1500mm

The three dots indicated in the codes of the products substitute, on this page, the three numbers of the finishing that may be ordered. For the Giesse finishing code, please refer to the "How to order" section on page 27.

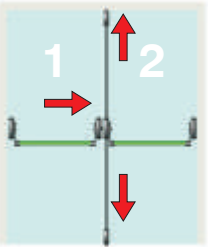
Type	Pcs.	Description	Code	Notes
	1	GS AP001 F lateral mechanism	07310...	
	1	GS AP001 top/bottom bar	07831...N	
	1	Short vertical suppl. latches Long vertical suppl. latches	07315... 07316...	For door heights up to 2640mm For door heights from 2641 to 3150mm
	2	950mm bar 1150mm bar 1450mm bar	07843... 07844... 07845...	For door widths up to 1000mm For door widths from 1001 to 1200mm For door widths from 1201 to 1500mm

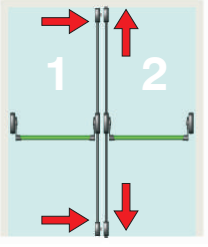
	2	GS AP001 top/bottom mechanism	07831...N	
	1	Short vertical suppl. latches Long vertical suppl. latches	07315... 07316...	For door heights up to 2640mm For door heights from 2641 to 3150mm
	1	Short lateral suppl. latches Long lateral suppl. latches	07317... 07318...	For door heights up to 2640mm For door heights from 2641 to 3150mm
	2	950mm bar 1150mm bar 1450mm bar	07843... 07844... 07845...	For door widths up to 1000mm For door widths from 1001 to 1200mm For door widths from 1201 to 1500mm

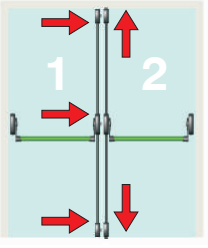
	1	GS AP001 top/bottom mechanism	07831...N	
	1	GS AP001 F modular mechanism	07312...	
	1	Short vertical suppl. latches Long vertical suppl. latches	07315... 07316...	For door heights up to 2640mm For door heights from 2641 to 3150mm
	1	Short lateral suppl. latches Long lateral suppl. latches	07317... 07318...	For door heights up to 2640mm For door heights from 2641 to 3150mm
	2	950mm bar 1150mm bar 1450mm bar	07843... 07844... 07845...	For door widths up to 1000mm For door widths from 1001 to 1200mm For door widths from 1201 to 1500mm

1 = main wing
2 = secondary wing

The three dots indicated in the codes of the products substitute, on this page, the three numbers of the finishing that may be ordered. For the Giesse finishing code, please refer to the "How to order" section on page 27

PANIC EXIT DEVICES GIESSE

Configurations GS AP002

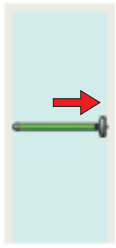
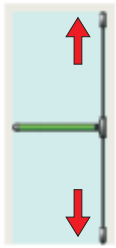
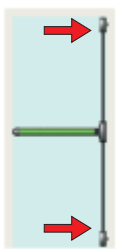
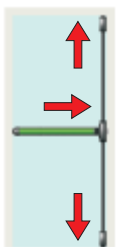
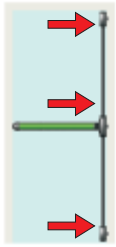
Type	Pcs.	Description	Code	Notes	
	1	GS AP002 short lateral mechanism GS AP002 medium lateral mechanism GS AP002 long lateral mechanism	07410... 07411... 07412...	For door widths up to 1000mm For door widths from 1001 to 1200mm For door widths from 1201 to 1500mm	
		1	GS AP002 short top/bottom mechanism GS AP002 medium top/bottom mechanism GS AP002 long top/bottom mechanism	07413... 07414... 07415...	For door widths up to 1000mm For door widths from 1001 to 1200mm For door widths from 1201 to 1500mm
		1	Short vertical suppl. latches Long vertical suppl. latches	07835...N 07836...N	For door heights up to 2640mm For door heights from 2641 to 3150mm
	1	GS AP002 short top/bottom mechanism GS AP002 medium top/bottom mechanism GS AP002 long top/bottom mechanism	07413... 07414... 07415...	For door widths up to 1000mm For door widths from 1001 to 1200mm For door widths from 1201 to 1500mm	
	1	Short lateral suppl. latches Long lateral suppl. latches	07837...N 07838...N	For door heights up to 2640mm For door heights from 2641 to 3150mm	
	1	GS AP002 short modular mechanism GS AP002 medium modular mechanism GS AP002 long modular mechanism	07416... 07417... 07418...	For door widths up to 1000mm For door widths from 1001 to 1200mm For door widths from 1201 to 1500mm	
	1	Short vertical suppl. latches Long vertical suppl. latches	07835...N 07836...N	For door heights up to 2640mm For door heights from 2641 to 3150mm	
	1	GS AP002 short modular mechanism GS AP002 medium modular mechanism GS AP002 long modular mechanism	07416... 07417... 07418...	For door widths up to 1000mm For door widths from 1001 to 1200mm For door widths from 1201 to 1500mm	
	1	Short lateral suppl. latches Long lateral suppl. latches	07837...N 07838...N	For door heights up to 2640mm For door heights from 2641 to 3150mm	

The three dots indicated in the codes of the products substitute, on this page, the three numbers of the finishing that may be ordered. For the Giesse finishing code, please refer to the "How to order" section on page 27..

Type	Pcs.	Description	Code	Notes
	1	GS AP002 short lateral mechanism	07410...	For door widths up to 1000 mm
		GS AP002 medium lateral mechanism	07411...	For door widths from 1001 to 1200 mm
		GS AP002 long lateral mechanism	07412...	For door widths from 1201 to 1500 mm
	1	GS AP002 short top/bottom mechanism	07413...	For door widths up to 1000 mm
		GS AP002 medium top/bottom mechanism	07414...	For door widths from 1001 to 1200 mm
	GS AP002 long top/bottom mechanism	07415...	For door widths from 1201 to 1500 mm	
1	Short vertical suppl. latches	07835...N	For door heights up to 2640mm	
	Long vertical suppl. latches	07836...N	For door heights from 2641 to 3150 mm	

	2	GS AP002 short top/bottom mechanism	07413...	For door widths up to 1000 mm
		GS AP002 medium top/bottom mechanism	07414...	For door widths from 1001 to 1200 mm
		GS AP002 long top/bottom mechanism	07415...	For door widths from 1201 to 1500 mm
	1	Short vertical suppl. latches	07835...N	For door heights up to 2640mm
		Long vertical suppl. latches	07836...N	For door heights from 2641 to 3150 mm
	1	Short lateral suppl. latches	07837...N	For door heights up to 2640mm
Long lateral suppl. latches		07838...N	For door heights from 2641 to 3150 mm	

	1	GS AP002 short modular mechanism	07416...	For door widths up to 1000 mm
		GS AP002 medium modular mechanism	07417...	For door widths from 1001 to 1200 mm
		GS AP002 long modular mechanism	07418...	For door widths from 1201 to 1500 mm
	1	GS AP002 short top/bottom mechanism	07413...	For door widths up to 1000 mm
		GS AP002 medium top/bottom mechanism	07414...	For door widths from 1001 to 1200 mm
		GS AP002 long top/bottom mechanism	07415...	For door widths from 1201 to 1500 mm
	1	Short vertical suppl. latches	07835...N	For door heights up to 2640mm
		Long vertical suppl. latches	07836...N	For door heights from 2641 to 3150 mm
1	Short lateral suppl. latches	07837...N	For door heights up to 2640mm	
	Long lateral suppl. latches	07838...N	For door heights from 2641 to 3150 mm	

1 = main wing
2 = secondary wing

The three dots indicated in the codes of the products substitute, on this page, the three numbers of the finishing that may be ordered. For the Giesse finishing code, please refer to the "How to order" section on page 27

PANIC EXIT DEVICES GIESSE

Configurations GS AP002 F

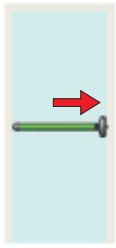
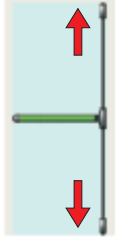
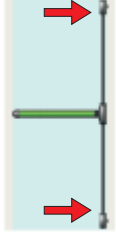
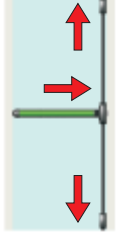
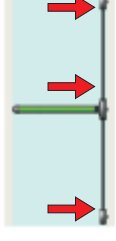
Type	Pcs.	Description	Code	Notes	
	1	GS AP002 F short lateral mechanism GS AP002 F medium lateral mechanism GS AP002 F long lateral mechanism	07420... 07421... 07422...	For door widths up to 1000 mm For door widths from 1001 to 1200 mm For door widths from 1201 to 1500 mm	
		1	GS AP002 short top/bottom mechanism GS AP002 medium top/bottom mechanism GS AP002 long top/bottom mechanism	07413... 07414... 07415...	For door widths up to 1000 mm For door widths from 1001 to 1200 mm For door widths from 1201 to 1500 mm
		1	Short vertical suppl. latches Long vertical suppl. latches	07315... 07316...	For door heights up to 2640mm For door heights from 2641 to 3150 mm
	1	GS AP002 short top/bottom mechanism GS AP002 medium top/bottom mechanism GS AP002 long top/bottom mechanism	07413... 07414... 07415...	For door widths up to 1000 mm For door widths from 1001 to 1200 mm For door widths from 1201 to 1500 mm	
	1	Short lateral suppl. latches Long lateral suppl. latches	07317... 07318...	For door heights up to 2640mm For door heights from 2641 to 3150 mm	
	1	GS AP002 F short modular mechanism GS AP002 F medium modular mechanism GS AP002 F long modular mechanism	07426... 07427... 07428...	For door widths up to 1000 mm For door widths from 1001 to 1200 mm For door widths from 1201 to 1500 mm	
	1	Short vertical suppl. latches Long vertical suppl. latches	07315... 07316...	For door heights up to 2640mm For door heights from 2641 to 3150 mm	
	1	GS AP002 F short modular mechanism GS AP002 F medium modular mechanism GS AP002 F long modular mechanism	07426... 07427... 07428...	For door widths up to 1000 mm For door widths from 1001 to 1200 mm For door widths from 1201 to 1500 mm	
	1	Short lateral suppl. latches Long lateral suppl. latches	07317... 07318...	For door heights up to 2640mm For door heights from 2641 to 3150 mm	

The three dots indicated in the codes of the products substitute, on this page, the three numbers of the finishing that may be ordered. For the Giesse finishing code, please refer to the "How to order" section on page 27

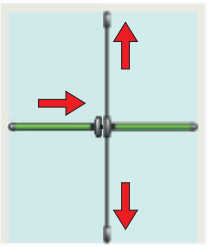
Type	Pcs.	Description	Code	Notes
	1	GS AP002 short lateral mechanism	07410...	For door widths up to 1000 mm
		GS AP002 medium lateral mechanism	07411...	For door widths from 1001 to 1200 mm
		GS AP002 long lateral mechanism	07412...	For door widths from 1201 to 1500 mm
	1	GS AP002 short top/bottom mechanism	07413...	For door widths up to 1000 mm
		GS AP002 medium top/bottom mechanism	07414...	For door widths from 1001 to 1200 mm
		GS AP002 long top/bottom mechanism	07415...	For door widths from 1201 to 1500 mm
1	Short vertical suppl. latches	07315...	For door heights up to 2640mm	
	Long vertical suppl. latches	07316...	For door heights from 2641 to 3150 mm	

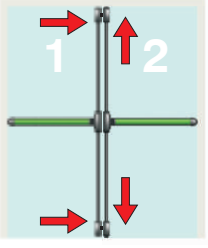
	2	GS AP002 short top/bottom mechanism	07413...	For door widths up to 1000 mm
		GS AP002 medium top/bottom mechanism	07414...	For door widths from 1001 to 1200 mm
		GS AP002 long top/bottom mechanism	07415...	For door widths from 1201 to 1500 mm
	1	Short vertical suppl. latches	07315...	For door heights up to 2640mm
		Long vertical suppl. latches	07316...	For door heights from 2641 to 3150 mm
	1	Short lateral suppl. latches	07317...	For door heights up to 2640mm
Long lateral suppl. latches		07318...	For door heights from 2641 to 3150 mm	

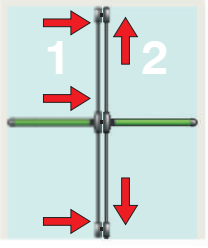
	1	GS AP002 F short modular mechanism	07426...	For door widths up to 1000 mm
		GS AP002F medium modular mechanism	07427...	For door widths from 1001 to 1200 mm
		GS AP002 F long modular mechanism	07428...	For door widths from 1201 to 1500 mm
	1	GS AP002 short top/bottom mechanism	07413...	For door widths up to 1000 mm
		GS AP002 medium top/bottom mechanism	07414...	For door widths from 1001 to 1200 mm
		GS AP002 long top/bottom mechanism	07415...	For door widths from 1201 to 1500 mm
	1	Short vertical suppl. latches	07315...	For door heights up to 2640mm
		Long vertical suppl. latches	07316...	For door heights from 2641 to 3150 mm
1	Short lateral suppl. latches	07317...	For door heights up to 2640mm	
	Long lateral suppl. latches	07318...	For door heights from 2641 to 3150 mm	

1 = main wing
2 = secondary wing

The three dots indicated in the codes of the products substitute, on this page, the three numbers of the finishing that may be ordered. For the Giesse finishing code, please refer to the "How to order" section on page 27

PANIC EXIT DEVICES GIESSE

Configurations of GS AP100

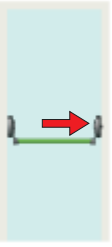
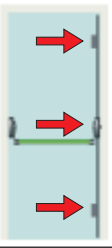
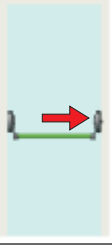
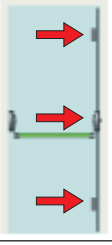
Type	Pcs.	Description	Code	Notes
FOR PROFILES WITH GROOVE 	1	GS AP100 mechanism	07833...	
	1	950 mm bar	07843...	For door widths up to 1.000 mm
		1.150 mm bar	07844...	For door widths up to 1.200 mm
		1.450 mm bar	07845...	For door widths up to 1.500 mm
	1	Central lock, flat face plate	07643000	25 mm cylinder backset
		Central lock, flat face plate	07644000	30 mm cylinder backset
Central lock, flat face plate		07645000	35 mm cylinder backset	
1	Adjustable striker for GS AP100	(*)	For various types of profile	
1	Double Europrofile cylinder	(*)		
FOR PROFILES WITH GROOVE 	1	GS AP100 mechanism	07833...	
	1	950 mm bar	07843...	For door widths up to 1.000 mm
		1.150 mm bar	07844...	For door widths up to 1.200 mm
		1.450 mm bar	07845...	For door widths up to 1.500 mm
	1	Multipoint lock, flat face plate	07653000	25 mm cylinder backset
		Multipoint lock, flat face plate	07654000	30 mm cylinder backset
Multipoint lock, flat face plate		07655000	35 mm cylinder backset	
1	Adjustable striker for GS AP100	(*)	For various types of profile	
1	Double Europrofile cylinder	(*)		
FOR PROFILES WITHOUT GROOVE 	1	GS AP100 mechanism	07833...	
	1	950 mm bar	07843...	For door widths up to 1.000 mm
		1.150 mm bar	07844...	For door widths up to 1.200 mm
		1.450 mm bar	07845...	For door widths up to 1.500 mm
	1	Central lock, "U"-shaped face plate	07640000	25 mm cylinder backset
		Central lock, "U"-shaped face plate	07641000	30 mm cylinder backset
Central lock, "U"-shaped face plate		07642000	35 mm cylinder backset	
1	Adjustable striker for GS AP100	(*)	For various types of profile	
1	Double Europrofile cylinder	(*)		
FOR PROFILES WITHOUT GROOVE 	1	GS AP100 mechanism	07833...	
	1	950 mm bar	07843...	For door widths up to 1.000 mm
		1.150 mm bar	07844...	For door widths up to 1.200 mm
		1.450 mm bar	07845...	For door widths up to 1.500 mm
	1	Multipoint lock, "U"-shaped face plate	07650000	25 mm cylinder backset
		Multipoint lock, "U"-shaped face plate	07651000	30 mm cylinder backset
Multipoint lock, "U"-shaped face plate		07652000	35 mm cylinder backset	
1	Adjustable striker for GS AP100	(*)	For various types of profile	
1	Double Europrofile cylinder	(*)		

(*) : See "Codes and finishes"

The three dots indicated in the codes of the products substitute, on this page, the three numbers of the finishing that may be ordered. For the Giesse finishing code, please refer to the "How to order" section on page 27.

PANIC EXIT DEVICES GIESSE

Accessories



External control

The external control common to all GS AP001 panic exit devices enables operation of the bar to be impeded, thus preventing opening from the outside. It can be combined with all the configurations indicated.



Latch striker for fire doors

The fire door versions differ from the standard versions in the use of specific stainless steel strikers, which ensure that the safety device works, and thus the door opens, also in the event of a fire.



Latch striker

The adjustable bolt striker to be placed in a position corresponding to the lateral or vertical latches of GS AP001 and GS AP002. It is supplied with the panic exit devices and supplementary latches.



Floor latch striker

The floor striker to be placed in a position corresponding to the bottom vertical bolt of GS AP001 and GS AP002. It is supplied with the panic exit devices and supplementary latches.



Double cylinder

The GS AP100 range has to be coupled with half and double europrofile cylinders.

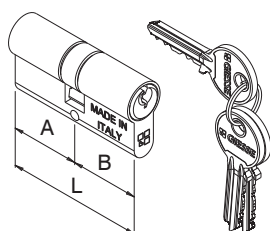

Half cylinder

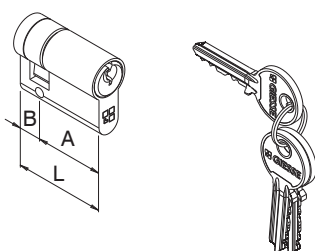

CODE	COMMERCIAL DIMENSION	L	A	B
07680	31/31	62	31	31
07681	37/27	64	37	27
07682	35/35	70	35	35
07683	41/31	72	41	31
07684	41/41	82	41	41
07685	51/31	82	51	31
07687	61/31	92	61	31
07688	41/51	92	41	51
07689	91/31	122	91	31

CODE	COMMERCIAL DIMENSION	L	A	B
07686	31/10	41	31	10

CODES



PANIC EXIT DEVICES GIESSE

How to order

Giesse has adopted and defined rules for codification of the finished products, so as to enable them to be identified uniquely and to ensure that

that they can be traced in stores and on the computer system managing the business processes. All references you find on catalogues

or price lists contain an alphanumeric code which defines their characteristics. These rules are summarised in the example given below:

Identification of the article

Example: Article 07830410N
GS AP001 lateral mechanism

07830 . . . N

Product root

This is made up of the first **5** characters of the code plus the **9th** character if any. In the case examined the product root is: 07830N.

Finish

This is made up of the **6th, 7th** and **8th** characters of the code. To complete the product code, “...” has to be replaced with the finish code according the following **FINISHES AND CODES TABLE**.

Auxiliary characteristics of the product

It consists of the 9th (alphanumeric) character. It identifies a particular variant of a standard product which is decided

case by case and often is not used.

FINISHES AND CODES TABLE

BASE/ROUGH: articles which exist only with a type of finish which is considered basic (E.g. 00350000) or articles with rough finishes that exist also with other finishes (E.g. 00120000N).

ANODISED/ELOX: articles with Electrocolour and Oxidised finishes.

TREND/GOLD/BRASS: articles with Trend, oxidised Gold, or Brass finishes.

PAINTED: painted articles.

SPECIAL FINISHES: articles with special paints.

TO ORDER: articles made to order with oxidised or painted finishes.

STANDARD 5 : high turnover products

SPECIAL 20 : low turnover products

BASE/RAW	ANODISED/ELOX		TREND/GOLD/BRASS		
000 rough/stainless steel/nylon 005 base primer 010 black nylon 501 matt black	STANDARD 5	SPECIAL 20	STANDARD 5	STANDARD 5	SPECIAL 20
	020 silver 190 electrogiesse 9	060 bronze 150 electrogiesse 5	040 gold 310 trend gold	350 trend cromosat	325 trend nickelsat 340 trend chrome 360 satined brass 361 bronzed brass
PLASTIC POLYMERS	PAINTED		SPECIAL FINISHES		TO ORDER
538 green 541 Ral 1013 pearl white 542 clear grey 544 grey 559 dark brown 560 white 580 red 590 black	STANDARD 5	SPECIAL 20	SPECIAL 20		300 Oxidation 600 Painted
	372 silver metal 410 pure white 412 Ral 9003 polished white 413 Ral 9010 polished white 414 Ral 1015 clear avory 430 Ral 1013 pearl white 461 Ral 3000 red 470 Ral 9016 white 500 Ral 9005 black 610 white (French) 9010 611 Ral 9010 white 700 Ral 6029 Giesse Green 970 Ral 9006 silver	380 bronze euro 382 Giesse dark bronze 390 electro 5 euro 411 RAL 9010 white, 25% Gloss 420 Ral 9001 cream white 460 Ral 3003 ruby red 480 Ral 6005 musk green 490 Ral 8017 chocolate brown 510 mat green SFX * 520 mat red SFX * 530 mat gray SFX * 620 dark bronze 640 Ral 8019 brown painted 641 Ral 8019 mat brown 650 musk brown Grinz 660 musk green Grinz 670 mat brown SFX * 680 Ral 9002 white 790 Ral 9016 bright white 960 Ral 1247 dark brown 980 michelangelo white	373 metallized silver 374 silver Velvet 502 black Velvet 740 shot-blasting		

* SFX finishes are available only for some articles. Silver, Bronze and Electrogiesse 5 finishes of die-cast cremone latches of the EURO, PRIMA, SUPERMASTER, NOVA, SUPERNOVA and COUPE' lines must always be ordered with the following codes:
372 Silver Met Painted
380 Euro Bronze Painted
390 Euro Electrofive Painted

N.B. Some articles of the Giesse range cannot be made with all the finishes indicated in the table. For further clarification and information please contact the Giesse Customer Care Service.

PANIC EXIT DEVICES GIESSE

List of finishes available by article code

Code	Description	Base/ Raw	Anodised/ Elox		Painted		Trend/ Gold/ Brass			Special finishes	To order	Pieces x pack.
			ST.5	SP.20	ST.5	SP.20	ST.5	ST.5	SP.20			
MECHANISMS												
07830...N	GS AP001 LATERAL				X							1
07831...N	GS AP001 TOP/BOTTOM <i>suitable for fire doors</i>				X							1
07832...N	GS AP001 MODULAR				X							1
07310...	GS AP001 F LATERAL <i>suitable for fire doors</i>				X							1
07312...	GS AP001 F MODULAR <i>suitable for fire doors</i>				X							1
07410...	GS AP002 SHORT LATERAL				X							1
07411...	GS AP002 MEDIUM LATERAL				X							1
07412...	GS AP002 LONG LATERAL				X							1
07413...	GS AP002 SHORT TOP/BOTTOM <i>suitable for fire doors</i>				X							1
07414...	GS AP002 MEDIUM TOP/BOTTOM <i>suitable for fire doors</i>				X							1
07415...	GS AP002 LONG TOP/BOTTOM <i>suitable for fire doors</i>				X							1
07416...	GS AP002 SHORT MODULAR				X							1
07417...	GS AP002 MEDIUM MODULAR				X							1
07418...	GS AP002 LONG MODULAR				X							1
07420...	GS AP002 F SHORT LATERAL <i>suitable for fire doors</i>				X							1
07421...	GS AP002 F MEDIUM LATERAL <i>suitable for fire doors</i>				X							1
07422...	GS AP002 F LONG LATERAL <i>suitable for fire doors</i>				X							1
07426...	GS AP002 F SHORT MODULAR <i>suitable for fire doors</i>				X							1
07427...	GS AP002 F MEDIUM MODULAR <i>suitable for fire doors</i>				X							1
07428...	GS AP002 F LONG MODULAR <i>suitable for fire doors</i>				X							1
07833...	GS AP100				X							1
BARS FOR GS AP001 AND GS AP100												
07843...	950 mm BAR <i>for door widths up to 1000 mm</i>				X							1
07844...	1150 mm BAR <i>for door widths up to 1200 mm</i>				X							1
07845...	1450 mm BAR <i>for door widths up to 1500 mm</i>				X							1

The three dots indicated in the codes of the products substitute, on this page, the three numbers of the finishing that may be ordered. For the Giesse finishing code, please refer to the "How to order" section on page 27

Code	Description	Base/ Raw	Anodised/ Elox		Painted		Trend/ Gold/ Brass			Special finishes	To order	Pieces x pack.
			ST.5	SP.20	ST.5	SP.20	ST.5	ST.5	SP.20			
SUPPLEMENTARY LATCHES FOR GS AP001 AND GS AP002												
07835...N	SHORT VERTICAL SUPPL. LATCHES for door heights up to 2640 mm				X							1
07836...N	LONG VERTICAL SUPPL. LATCHES for door heights from 2641 to 3150 mm				X							1
07315...	SHORT VERTICAL SUPPL. LATCHES for door heights up to 2640 mm - suitable for fire doors				X							1
07316...	LONG VERTICAL SUPPL. LATCHES for door heights from 2641 to 3150 mm - suitable for fire doors				X							1
07837...N	SHORT LATERAL SUPPL. LATCHES for door heights up to 2640 mm				X							1
07838...N	LONG LATERAL SUPPL. LATCHES for door heights from 2641 to 3150 mm				X							1
07317...	SHORT LATERAL SUPPL. LATCHES for door heights up to 2640 mm - suitable for fire doors				X							1
07318...	LONG LATERAL SUPPL. LATCHES for door heights from 2641 to 3150 mm - suitable for fire doors				X							1
LOCKS FOR GS AP100												
07643000	CENTRAL LOCK, FLAT FACE PLATE 25 mm cylinder backset	X										1
07644000	CENTRAL LOCK, FLAT FACE PLATE 30 mm cylinder backset	X										1
07645000	CENTRAL LOCK, FLAT FACE PLATE 35 mm cylinder backset	X										1
07653000	MULTIPOINT LOCK, FLAT FACE PLATE 25 mm cylinder backset	X										1
07654000	MULTIPOINT LOCK, FLAT FACE PLATE 30 mm cylinder backset	X										1
07655000	MULTIPOINT LOCK, FLAT FACE PLATE 35 mm cylinder backset	X										1
07640000	CENTRAL LOCK, "U"-SHAPED FACE PLATE 25 mm cylinder backset	X										1
07641000	CENTRAL LOCK, "U"-SHAPED FACE PLATE 30 mm cylinder backset	X										1
07642000	CENTRAL LOCK, "U"-SHAPED FACE PLATE 35 mm cylinder backset	X										1
07650000	MULTIPOINT LOCK, "U"-SHAPED FACE PLATE 25 mm cylinder backset	X										1
07651000	MULTIPOINT LOCK, "U"-SHAPED FACE PLATE 30 mm cylinder backset	X										1
07652000	MULTIPOINT LOCK, "U"-SHAPED FACE PLATE 35 mm cylinder backset	X										1

The three dots indicated in the codes of the products substitute, on this page, the three numbers of the finishing that may be ordered. For the Giesse finishing code, please refer to the "How to order" section on page 27

PANIC EXIT DEVICES GIESSE

List of finishes available by article code

Code	Description	Base/ Raw	Anodised/ Elox		Painted		Trend/ Gold/ Brass			Special finishes	To order	Pieces x pack.
			ST.5	SP.20	ST.5	SP.20	ST.5	ST.5	SP.20			
ADJUSTABLE STRIKERS FOR GS AP100												
07690000	STRIKER FOR EURO GROOVE PROFILES groove 13.5/18 mm	X										1
07691000	STRIKER FOR DOOR PROFILES	X										1
07692000	STRIKER FOR PROFILES WITH GROOVE 15/20 mm air from 12 to 15 mm	X										1
07693000	STRIKER FOR R40 AND R50 PROFILES	X										1
07694000	STRIKER FOR PROFILES WITH GROOVE 15/20 mm air > 15 mm	X										1
07695000	STRIKER FOR UNIVERSAL FLAT PROFILE	X										1
07700000	STRIKER KIT FOR EURO GROOVE PROFILES for multipoint locks – groove 13.5/18 mm	X										1
07701000	STRIKER KIT FOR DOOR PROFILES for multipoint locks	X										1
07702000	STRIKER KIT FOR PROFILES WITH GROOVE 15/20 mm for multipoint locks - air from 12 to 15 mm	X										1
07703000	STRIKER KIT FOR R40 AND R50 PROFILES for multipoint locks	X										1
07704000	STRIKER KIT FOR PROFILES WITH GROOVE 15/20 mm for multipoint locks - air > 15 mm	X										1
07705000	STRIKER KIT FOR UNIVERSAL FLAT PROFILE for multipoint locks	X										1

DOUBLE EUROPROFILE CYLINDERS FOR GS AP100												
07680000	CENTRAL DOUBLE SYMETRIC CYLINDER L = 62 (31 - 31) mm	X										10
07681000	DOUBLE ASYMETRIC CYLINDER L = 64 (37 - 27) mm	X										10
07682000	CENTRAL DOUBLE SYMETRIC CYLINDER L = 70 (35 - 35) mm	X										10
07683000	DOUBLE ASYMETRIC CYLINDER L = 72 (41 - 31) mm	X										10
07684000	CENTRAL DOUBLE SYMETRIC CYLINDER L = 82 (41 - 41) mm	X										10
07685000	DOUBLE ASYMETRIC CYLINDER L = 82 (51 - 31) mm	X										10
07687000	DOUBLE ASYMETRIC CYLINDER L = 92 (61 - 31) mm	X										10
07688000	CENTRAL DOUBLE SYMETRIC CYLINDER L = 92 (41 - 51) mm	X										10
07689000	DOUBLE ASYMETRIC CYLINDER L = 122 (91 - 31) mm	X										10

The three dots indicated in the codes of the products substitute, on this page, the three numbers of the finishing that may be ordered. For the Giesse finishing code, please refer to the "How to order" section on page 27

Code	Description	Base/ Raw	Anodised/ Elox		Painted		Trend/ Gold/ Brass			Special finishes	To order	Pieces x pack.
			ST.5	SP.20	ST.5	SP.20	ST.5	ST.5	SP.20			

EXTERNAL CONTROL FOR GS AP001 AND GS AP002

07320...	OUTSIDE ACCESS DEVICE - HANDLE WITH KEY				X							1
07321...	OUTSIDE ACCESS DEVICE - HANDLE W/OUT CYLINDER				X							1
07322...	OUTSIDE ACCESS DEVICE - KNOB WITH KEY				X							1
07323...	OUTSIDE ACCESS DEVICE - KNOB W/OUT CYLINDER				X							1
07686000	CYLINDER FOR EXTERNAL CONTROL L = 41 (31 - 10) mm	X										1

LATCH STRIKERS FOR GS AP001 AND GS AP002

07472000	LATCH STRIKER	X										10
07471000	FLOOR LATCH STRIKER	X										10
07470000	LATCH STRIKER VERS. FIRE DOORS	X										10
07473000	LATERAL STRIKER FOR PVC	X										10



www.giesse.it



 **GIESSE**[®]



U0116101/02-2011